

Capacidad para hasta 700 kg.

Tipos de Fijaciones

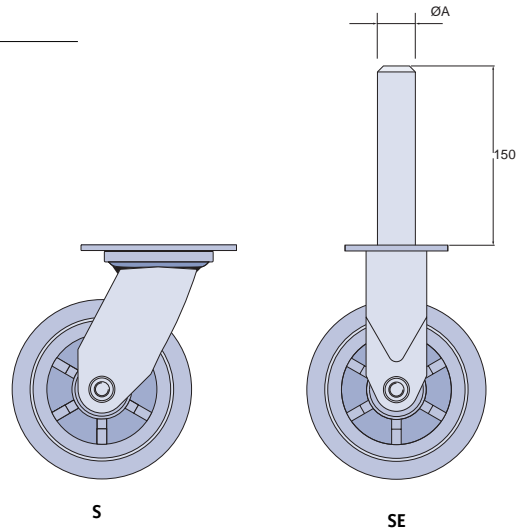

Ruedas

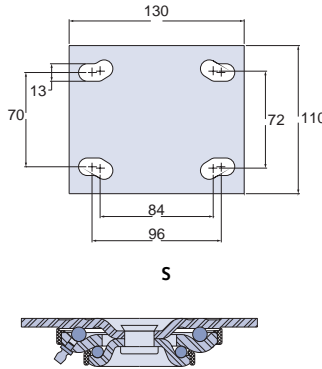

RIT – Neumática



Ruedas Champion

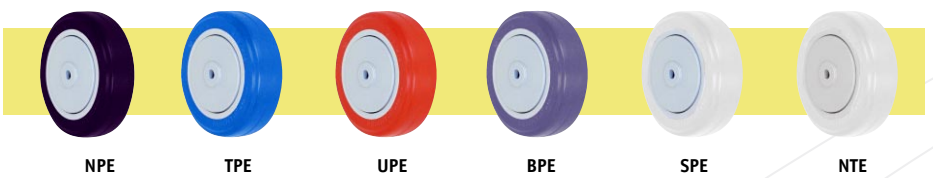

Tipos de Rodaje



Accesorios

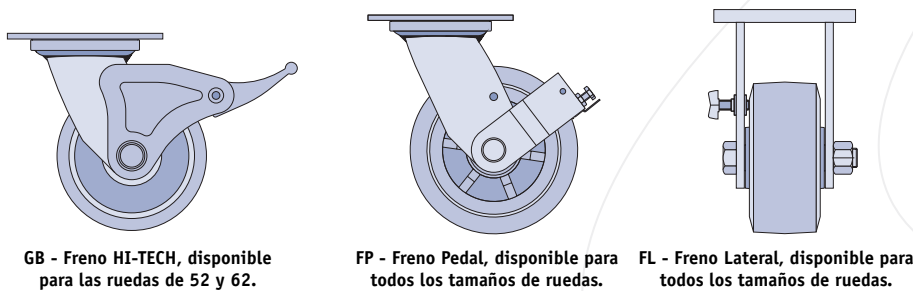

Fijación por Espiga

CÓDIGO	$\varnothing A$
SE1	1"
SE2	1.1/4"
SE3	1.5/16"







SE

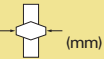
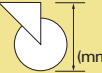

Dimensiones en mm

							Ref. Rueda	Ref. Rodaja con Placa	
4"	1.½"	½"	48	138	87	85	R 414 BPN	GS 414 BPN	FS 414 BPN
						125	R 414 NPN	GS 414 NPN	FS 414 NPN
						100	R 414 TPN	GS 414 TPN	FS 414 TPN
						125	R 414 UPN	GS 414 UPN	FS 414 UPN
						100	R 414 SPN	GS 414 SPN	FS 414 SPN
						130	R 414 CN	GS 414 CN	FS 414 CN
						120	R 414 BN	GS 414 BN	FS 414 BN
						200	R 414 PN	GS 414 PN	FS 414 PN
						200	R 414 FN	GS 414 FN	FS 414 FN
5"	1.½"	½"	48	165	100	115	R 514 BPN	GS 514 BPN	FS 514 BPN
						150	R 514 NPN	GS 514 NPN	FS 514 NPN
						125	R 514 TPN	GS 514 TPN	FS 514 TPN
						150	R 514 UPN	GS 514 UPN	FS 514 UPN
						125	R 514 SPN	GS 514 SPN	FS 514 SPN
						100	R 514 CN	GS 514 CN	FS 514 CN
						140	R 514 BN	GS 514 BN	FS 514 BN
						250	R 514 PN	GS 514 PN	FS 514 PN
						250	R 514 FN	GS 514 FN	FS 514 FN
6"	1.½"	½"	48	196	121	125	R 614 BPN	GS 614 BPN	FS 614 BPN
						160	R 614 NPN	GS 614 NPN	FS 614 NPN
						150	R 614 TPN	GS 614 TPN	FS 614 TPN
						160	R 614 UPN	GS 614 UPN	FS 614 UPN
						150	R 614 SPN	GS 614 SPN	FS 614 SPN
						180	R 614 CN	GS 614 CN	FS 614 CN
						170	R 614 BN	GS 614 BN	FS 614 BN
						300	R 614 PN	GS 614 PN	FS 614 PN
						300	R 614 FN	GS 614 FN	FS 614 FN
8"	1.5/8"	7/8"	54	235	153	150	R 816 BPN	GS 816 BPN	FS 816 BPN
						160	R 816 NPN	GS 816 NPN	FS 816 NPN
						155	R 816 TPN	GS 816 TPN	FS 816 TPN
						160	R 816 UPN	GS 816 UPN	FS 816 UPN
9"	1.5/8"	7/8"	54	280	180	160	R 916 BPN	GS 916 BPN	FS 916 BPN
						170	R 916 NPN	GS 916 NPN	FS 916 NPN
						165	R 916 TPN	GS 916 TPN	FS 916 TPN
						170	R 916 UPN	GS 916 UPN	FS 916 UPN
10"	1.5/8"	7/8"	54	292	193	170	R 1016 BPN	GS 1016 BPN	FS 1016 BPN
						180	R 1016 NPN	GS 1016 NPN	FS 1016 NPN
						175	R 1016 TPN	GS 1016 TPN	FS 1016 TPN
						180	R 1016 UPN	GS 1016 UPN	FS 1016 UPN

Dimensiones en mm

							Ref. Rueda	Ref. Rodaja con Placa	
									
4"	1.½"	½"	48	138	87	120	R 414 BR	GS 414 BR	FS 414 BR
						200	R 414 PR	GS 414 PR	FS 414 PR
						200	R 414 FR	GS 414 FR	FS 414 FR
5"	1.½"	½"	48	165	100	140	R 514 BR	GS 514 BR	FS 514 BR
						250	R 514 PR	GS 514 PR	FS 514 PR
						250	R 514 FR	GS 514 FR	FS 514 FR
6"	1.½"	½"	48	196	121	170	R 614 BR	GS 614 BR	FS 614 BR
						300	R 614 PR	GS 614 PR	FS 614 PR
						300	R 614 FR	GS 614 FR	FS 614 FR









4"	1.¼"	½"	48	138	87	85	R 414 BPE	GS 414 BPE	FS 414 BPE
						125	R 414 NPE	GS 414 NPE	FS 414 NPE
						100	R 414 SPE	GS 414 SPE	FS 414 SPE
						100	R 414 TPE	GS 414 TPE	FS 414 TPE
						125	R 414 UPE	GS 414 UPE	FS 414 UPE
						125	R 414 NTE	GS 414 NTE	FS 414 NTE
5"	1.¼"	½"	48	165	100	115	R 514 BPE	GS 514 BPE	FS 514 BPE
						150	R 514 NPE	GS 514 NPE	FS 514 NPE
						125	R 514 SPE	GS 514 SPE	FS 514 SPE
						125	R 514 TPE	GS 514 TPE	FS 514 TPE
						150	R 514 UPE	GS 514 UPE	FS 514 UPE
						150	R 514 NTE	GS 514 NTE	FS 514 NTE
						100	R 514 AU	GS 514 AU	FS 514 AU
6"	1.¼"	½"	48	196	121	125	R 614 BPE	GS 614 BPE	FS 614 BPE
						160	R 614 NPE	GS 614 NPE	FS 614 NPE
						150	R 614 SPE	GS 614 SPE	FS 614 SPE
						150	R 614 TPE	GS 614 TPE	FS 614 TPE
						160	R 614 UPE	GS 614 UPE	FS 614 UPE
						160	R 614 NTE	GS 614 NTE	FS 614 NTE
8"	1.5/8"	7/8"	54	235	153	150	R 816 BPE	GS 816 BPE	FS 816 BPE
						160	R 816 NPE	GS 816 NPE	FS 816 NPE
						155	R 816 TPE	GS 816 TPE	FS 816 TPE
						160	R 816 UPE	GS 816 UPE	FS 816 UPE
9"	1.5/8"	7/8"	54	280	180	160	R 916 BPE	GS 916 BPE	FS 916 BPE
						170	R 916 NPE	GS 916 NPE	FS 916 NPE
						165	R 916 TPE	GS 916 TPE	FS 916 TPE
						170	R 916 UPE	GS 916 UPE	FS 916 UPE
10"	1.5/8"	7/8"	54	292	193	170	R 1016 BPE	GS 1016 BPE	FS 1016 BPE
						180	R 1016 NPE	GS 1016 NPE	FS 1016 NPE
						175	R 1016 TPE	GS 1016 TPE	FS 1016 TPE
						180	R 1016 UPE	GS 1016 UPE	FS 1016 UPE

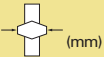

Dimensiones en mm

							Ref. Rueda	Ref. Rodaja con Placa	
4"	2"	5/8"	62	138	87	150	R 42 BPN	GS 42 BPN	FS 42 BPN
						250	R 42 UPN	GS 42 UPN	FS 42 UPN
						250	R 42 NTN	GS 42 NTN	FS 42 NTN
5"	2"	5/8"	62	165	100	175	R 52 BPN	GS 52 BPN	FS 52 BPN
						325	R 52 UPN	GS 52 UPN	FS 52 UPN
						325	R 52 NTN	GS 52 NTN	FS 52 NTN
6"	2"	5/8"	62	196	121	220	R 62 BPN	GS 62 BPN	FS 62 BPN
						400	R 62 UPN	GS 62 UPN	FS 62 UPN
						400	R 62 TM	GS 62 TM	FS 62 TM
8"	2"	7/8"	62	235	153	275	R 82 BPN	GS 82 BPN	FS 82 BPN
						550	R 82 UPN	GS 82 UPN	FS 82 UPN
			550			R 82 NTN	GS 82 NTN	FS 82 NTN	
			55			140	R 8200 N	GS 8200 N	FS 8200 N
9"	2"	7/8"	55	280	180	150	R 9200 N	GS 9200 N	FS 9200 N
10"	2"	7/8"	62	292	193	375	R 102 BPN	GS 102 BPN	FS 102 BPN
						700	R 102 UPN	GS 102 UPN	FS 102 UPN
			700			R 102 NTN	GS 102 NTN	FS 102 NTN	
			55			175	R 10200 N	GS 10200 N	FS 10200 N
215	60	7/8"	55	251	165	70	RIT 2504 N	GS 2504 N	FS 2504 N
							RIT 2504 PPN	GS 2504 PPN	FS 2504 PPN
270	80	7/8"	55	312	208	100	RIT 3504 N	GS 3504 N	FS 3504 N
							RIT 3504 PPN	GS 2504 PPN	FS 3504 PPN

Dimensiones en mm









							Ref. Rueda	Ref. Rodaja con Placa	
									
4"	2"	5/8"	62	138	87	150	R 42 BPR	GS 42 BPR	FS 42 BPR
						250	R 42 UPR	GS 42 UPR	FS 42 UPR
						250	R 42 NTR	GS 42 NTR	FS 42 NTR
						150	R 42 BR	GS 42 BR	FS 42 BR
						250	R 42 PR	GS 42 PR	FS 42 PR
						250	R 42 FR	GS 42 FR	FS 42 FR
5"	2"	5/8"	62	165	100	175	R 52 BPR	GS 52 BPR	FS 52 BPR
						325	R 52 UPR	GS 52 UPR	FS 52 UPR
						325	R 52 NTR	GS 52 NTR	FS 52 NTR
						175	R 52 BR	GS 52 BR	FS 52 BR
						325	R 52 PR	GS 52 PR	FS 52 PR
						325	R 52 FR	GS 52 FR	FS 52 FR
						250	R 52 CR	GS 52 CR	FS 52 CR
6"	2"	5/8"	62	196	121	220	R 62 BPR	GS 62 BPR	FS 62 BPR
						400	R 62 UPR	GS 62 UPR	FS 62 UPR
						400	R 62 NTR	GS 62 NTR	FS 62 NTR
						220	R 62 BR	GS 62 BR	FS 62 BR
						400	R 62 PR	GS 62 PR	FS 62 PR
						400	R 62 FR	GS 62 FR	FS 62 FR
						300	R 62 CR	GS 62 CR	FS 62 CR
						100	R 6200 R	GS 6200 R	FS 6200 R
7"	2"	5/8"	62	222	140	250	R 72 BR	GS 72 BR	FS 72 BR
						500	R 72 PR	GS 72 PR	FS 72 PR
						500	R 72 FR	GS 72 FR	FS 72 FR
8"	2"	7/8"	62	235	153	275	R 82 BR	GS 82 BR	FS 82 BR
						550	R 82 PR	GS 82 PR	FS 82 PR
			550			R 82 FR	GS 82 FR	FS 82 FR	
			400			R 82 CR	GS 82 CR	FS 82 CR	
			55			R 8200 R	GS 8200 R	FS 8200 R	
9"	2"	7/8"	62	280	180	275	R 92 BR	GS 92 BR	FS 92 BR
						550	R 92 PR	GS 92 PR	FS 92 PR
			550			R 92 FR	GS 92 FR	FS 92 FR	
			55			R 9200 R	GS 9200 R	FS 9200 R	
			150			R 9200 R	GS 9200 R	FS 9200 R	
10"	2"	7/8"	62	292	193	375	R 102 BR	GS 102 BR	FS 102 BR
						700	R 102 PR	GS 102 PR	FS 102 PR
			700			R 102 FR	GS 102 FR	FS 102 FR	
			55			R 10200 R	GS 10200 R	FS 10200 R	
215	60	7/8"	55	251	165	70	RIT 2504 R	GS 2504 R	FS 2504 R
270	80			312	208	100	RIT 3504 R	GS 3504 R	FS 3504 R

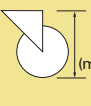
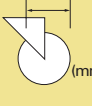

Dimensiones en mm

SERIE S – Export

SCHIOPPA

			 (mm)	 (mm)	 (mm)	 Kg	Ref. Rueda	Ref. Rodaja con Placa			
											
4"	2"	17	62	138	87	150	R 42 BPE	GS 42 BPE	FS 42 BPE		
						250	R 42 UPE	GS 42 UPE	FS 42 UPE		
						250	R 42 NTE	GS 42 NTE	FS 42 NTE		
						150	R 42 BE	GS 42 BE	FS 42 BE		
						250	R 42 PE	GS 42 PE	FS 42 PE		
						250	R 42 FE	GS 42 FE	FS 42 FE		
5"	2"	17	62	165	100	175	R 52 BPE	GS 52 BPE	FS 52 BPE		
						325	R 52 UPE	GS 52 UPE	FS 52 UPE		
						325	R 52 NTE	GS 52 NTE	FS 52 NTE		
						175	R 52 BE	GS 52 BE	FS 52 BE		
						325	R 52 PE	GS 52 PE	FS 52 PE		
						325	R 52 FE	GS 52 FE	FS 52 FE		
6"	2"	17	62	196	121	250	R 52 CE	GS 52 CE	FS 52 CE		
						220	R 62 BPE	GS 62 BPE	FS 62 BPE		
						400	R 62 UPE	GS 62 UPE	FS 62 UPE		
						400	R 62 NTE	GS 62 NTE	FS 62 NTE		
						220	R 62 BE	GS 62 BE	FS 62 BE		
						400	R 62 PE	GS 62 PE	FS 62 PE		
						400	R 62 FE	GS 62 FE	FS 62 FE		
7"	2"	17	62	222	140	300	R 62 CE	GS 62 CE	FS 62 CE		
						250	R 72 BE	GS 72 BE	FS 72 BE		
						500	R 72 PE	GS 72 PE	FS 72 PE		
8"	2"	20	62	235	153	500	R 72 FE	GS 72 FE	FS 72 FE		
						275	R 82 BPE	GS 82 BPE	FS 82 BPE		
						550	R 82 UPE	GS 82 UPE	FS 82 UPE		
						550	R 82 NTE	GS 82 NTE	FS 82 NTE		
		17	55	235	153	153	275	R 82 BE	GS 82 BE	FS 82 BE	
							550	R 82 PE	GS 82 PE	FS 82 PE	
							550	R 82 FE	GS 82 FE	FS 82 FE	
							400	R 82 CE	GS 82 CE	FS 82 CE	
							140	R 8200 E	GS 8200 E	FS 8200 E	
9"	2"	20	62	280	180	275	R 82 BE	GS 82 BE	FS 82 BE		
						550	R 82 PE	GS 82 PE	FS 82 PE		
		17	55	280	180	180	550	R 92 FE	GS 92 FE	FS 92 FE	
							150	R 9200 E	GS 9200 E	FS 9200 E	
10"	2"	20	62	292	193	375	R 102 BPE	GS 102 BPE	FS 102 BPE		
						700	R 102 UPE	GS 102 UPE	FS 102 UPE		
						700	R 102 NTE	GS 102 NTE	FS 102 NTE		
		17	55	292	193	193	193	375	R 102 BE	GS 102 BE	FS 102 BE
								700	R 102 PE	GS 102 PE	FS 102 PE
								700	R 102 FE	GS 102 FE	FS 102 FE
								175	R 10200 E	GS 10200 E	FS 10200 E
215	60	17	55	251	RIT 2504 E	GS 2504 E	FS 2504 E				
270	80			312	208	100	RIT 3504 E	GS 3504 E	FS 3504 E		

Dimensiones en mm