

Load capacity up to 700 kg.

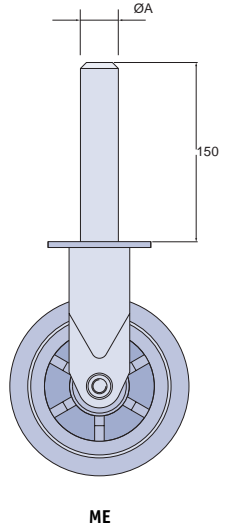

### Fastening Types

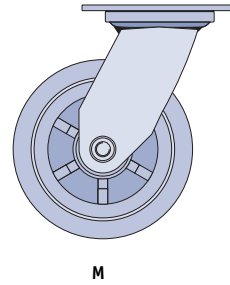
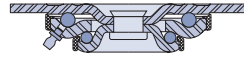

### Wheels



TP - Rubber

UP - Polyurethane

NT - Nylon

C - Celeron

P - Polyurethane

B - Rubber

F - Iron

R - Stamped medium

### RIT – Pneumatic



RIT

RIT - PP

### Wheel Rotation Types



Nylon socket

Roller bearing

Ball bearing

### Accessories

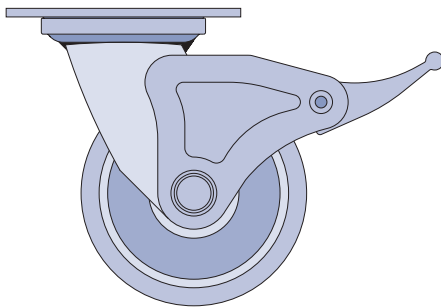

GB - HI-TECH brake, available for wheels of 5" and 6".

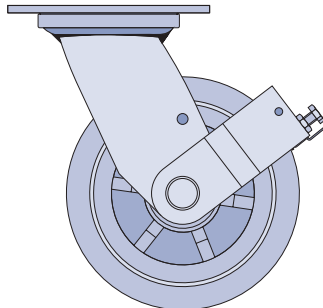

FP - Pedal brake, available for all wheel sizes.

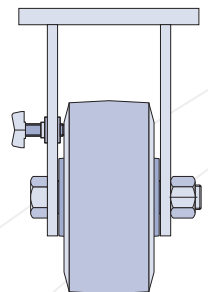

FL - Side brake, available for all wheel sizes.

### Top Plate Fastening

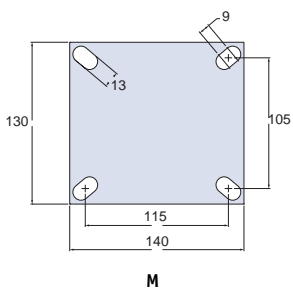

M

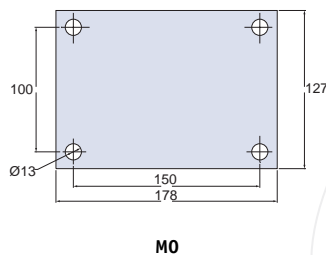

M0

### Steam Fastening

CODE	$\varnothing A$
ME1	1"
ME2	1.1/4"
ME3	1.5/16"









ME











All dimensions in mm

# M SERIES – Stamped Medium Duty

SCHIOPPA

							Ref. Wheel	Ref. Caster with Top Plate	
									
4"	2"	5/8"	62	138	87	150	R 42 BPN	GM 42 BPN	FM 42 BPN
						250	R 42 UPN	GM 42 UPN	FM 42 UPN
						250	R 42 NTN	GM 42 NTN	FM 42 NTN
5"	2"	5/8"	62	165	100	175	R 52 BPN	GM 52 BPN	FM 52 BPN
						325	R 52 UPN	GM 52 UPN	FM 52 UPN
						325	R 52 NTN	GM 52 NTN	FM 52 NTN
6"	2"	5/8"	62	196	121	220	R 62 BPN	GM 62 BPN	FM 62 BPN
						400	R 62 UPN	GM 62 UPN	FM 62 UPN
						400	R 62 TM	GM 62 TM	FM 62 TM
8"	2"	7/8"	62	235	153	275	R 82 BPN	GM 82 BPN	FM 82 BPN
						550	R 82 UPN	GM 82 UPN	FM 82 UPN
			550			R 82 NTN	GM 82 NTN	FM 82 NTN	
			55			140	R 8200 N	GM 8200 N	FM 8200 N
9"	2"	7/8"	55	280	180	150	R 9200 N	GM 9200 N	FM 9200 N
10"	2"	7/8"	62	292	193	375	R 102 BPN	GM 102 BPN	FM 102 BPN
						700	R 102 UPN	GM 102 UPN	FM 102 UPN
			700			R 102 NTN	GM 102 NTN	FM 102 NTN	
			55			175	R 10200 N	GM 10200 N	FM 10200 N
215	60	7/8"	55	251	165	70	RIT 2504 N	GM 2504 N	FM 2504 N
							RIT 2504 PPN	GM 2504 PPN	FM 2504 PPN
270	80		55	312	208	100	RIT 3504 N	GM 3504 N	FM 3504 N
							RIT 3504 PPN	GM 2504 PPN	FM 3504 PPN

All dimensions in mm







							Ref. Wheel	Ref. Caster with Top Plate	
									
4"	2"	5/8"	62	138	87	150	R 42 BPR	GM 42 BPR	FM 42 BPR
						250	R 42 UPR	GM 42 UPR	FM 42 UPR
						250	R 42 NTR	GM 42 NTR	FM 42 NTR
						150	R 42 BR	GM 42 BR	FM 42 BR
						250	R 42 PR	GM 42 PR	FM 42 PR
						250	R 42 FR	GM 42 FR	FM 42 FR
5"	2"	5/8"	62	165	100	175	R 52 BPR	GM 52 BPR	FM 52 BPR
						325	R 52 UPR	GM 52 UPR	FM 52 UPR
						325	R 52 NTR	GM 52 NTR	FM 52 NTR
						175	R 52 BR	GM 52 BR	FM 52 BR
						325	R 52 PR	GM 52 PR	FM 52 PR
						325	R 52 FR	GM 52 FR	FM 52 FR
						250	R 52 CR	GM 52 CR	FM 52 CR
6"	2"	5/8"	62	196	121	220	R 62 BPR	GM 62 BPR	FM 62 BPR
						400	R 62 UPR	GM 62 UPR	FM 62 UPR
						400	R 62 NTR	GM 62 NTR	FM 62 NTR
						220	R 62 BR	GM 62 BR	FM 62 BR
						400	R 62 PR	GM 62 PR	FM 62 PR
						400	R 62 FR	GM 62 FR	FM 62 FR
						300	R 62 CR	GM 62 CR	FM 62 CR
						100	R 6200 R	GM 6200 R	FM 6200 R
7"	2"	5/8"	62	222	140	250	R 72 BR	GM 72 BR	FM 72 BR
						500	R 72 PR	GM 72 PR	FM 72 PR
						500	R 72 FR	GM 72 FR	FM 72 FR
8"	2"	7/8"	62	235	153	275	R 82 BR	GM 82 BR	FM 82 BR
						550	R 82 PR	GM 82 PR	FM 82 PR
						550	R 82 FR	GM 82 FR	FM 82 FR
						400	R 82 CR	GM 82 CR	FM 82 CR
			55			R 8200 R	GM 8200 R	FM 8200 R	
9"	2"	7/8"	62	280	180	275	R 92 BR	GM 92 BR	FM 92 BR
						550	R 92 PR	GM 92 PR	FM 92 PR
						550	R 92 FR	GM 92 FR	FM 92 FR
						55			
			150			R 9200 R	GM 9200 R	FM 9200 R	
10"	2"	7/8"	62	292	193	375	R 102 BR	GM 102 BR	FM 102 BR
						700	R 102 PR	GM 102 PR	FM 102 PR
						700	R 102 FR	GM 102 FR	FM 102 FR
						55			
			175			R 10200 R	GM 10200 R	FM 10200 R	
215	60	7/8"	55	251	165	70	RIT 2504 R	GM 2504 R	FM 2504 R
270	80			312	208	100	RIT 3504 R	GM 3504 R	FM 3504 R

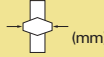
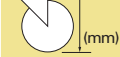

All dimensions in mm

# M SERIES – Stamped Medium Duty

SCHIOPPA

							Ref. Wheel	Ref. Caster with Top Plate		
										
4"	2"	17	62	138	87	150	R 42 BPE	GM 42 BPE	FM 42 BPE	
						250	R 42 UPE	GM 42 UPE	FM 42 UPE	
						250	R 42 NTE	GM 42 NTE	FM 42 NTE	
						150	R 42 BE	GM 42 BE	FM 42 BE	
						250	R 42 PE	GM 42 PE	FM 42 PE	
						250	R 42 FE	GM 42 FE	FM 42 FE	
5"	2"	17	62	165	100	175	R 52 BPE	GM 52 BPE	FM 52 BPE	
						325	R 52 UPE	GM 52 UPE	FM 52 UPE	
						325	R 52 NTE	GM 52 NTE	FM 52 NTE	
						175	R 52 BE	GM 52 BE	FM 52 BE	
						325	R 52 PE	GM 52 PE	FM 52 PE	
						325	R 52 FE	GM 52 FE	FM 52 FE	
						250	R 52 CE	GM 52 CE	FM 52 CE	
6"	2"	17	62	196	121	220	R 62 BPE	GM 62 BPE	FM 62 BPE	
						400	R 62 UPE	GM 62 UPE	FM 62 UPE	
						400	R 62 NTE	GM 62 NTE	FM 62 NTE	
						220	R 62 BE	GM 62 BE	FM 62 BE	
						400	R 62 PE	GM 62 PE	FM 62 PE	
						400	R 62 FE	GM 62 FE	FM 62 FE	
						300	R 62 CE	GM 62 CE	FM 62 CE	
7"	2"	17	62	222	140	250	R 72 BE	GM 72 BE	FM 72 BE	
						500	R 72 PE	GM 72 PE	FM 72 PE	
						500	R 72 FE	GM 72 FE	FM 72 FE	
8"	2"	20	62	235	153	275	R 82 BPE	GM 82 BPE	FM 82 BPE	
						550	R 82 UPE	GM 82 UPE	FM 82 UPE	
						550	R 82 NTE	GM 82 NTE	FM 82 NTE	
						275	R 82 BE	GM 82 BE	FM 82 BE	
		17	55	235	153	153	550	R 82 PE	GM 82 PE	FM 82 PE
							550	R 82 FE	GM 82 FE	FM 82 FE
							400	R 82 CE	GM 82 CE	FM 82 CE
							140	R 8200 E	GM 8200 E	FM 8200 E
9"	2"	20	62	280	180	275	R 92 BE	GM 92 BE	FM 92 BE	
						550	R 92 PE	GM 92 PE	FM 92 PE	
		17	55	280	180	180	550	R 92 FE	GM 92 FE	FM 92 FE
10"	2"	20	62	292	193	375	R 102 BPE	GM 102 BPE	FM 102 BPE	
						700	R 102 UPE	GM 102 UPE	FM 102 UPE	
						700	R 102 NTE	GM 102 NTE	FM 102 NTE	
						375	R 102 BE	GM 102 BE	FM 102 BE	
		17	55	292	193	193	700	R 102 PE	GM 102 PE	FM 102 PE
							700	R 102 FE	GM 102 FE	FM 102 FE
							175	R 10200 E	GM 10200 E	FM 10200 E
215	60	17	55	251	165	70	RIT 2504 E	GM 2504 E	FM 2504 E	
270	80			312	208	100	RIT 3504 E	GM 3504 E	FM 3504 E	

All dimensions in mm