

Load capacity up to 1200 kg.

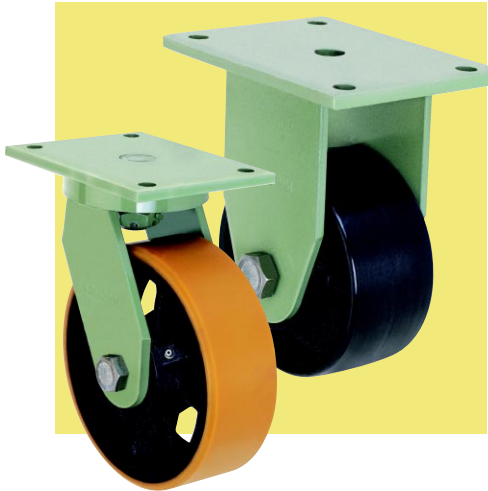

Fastening Types

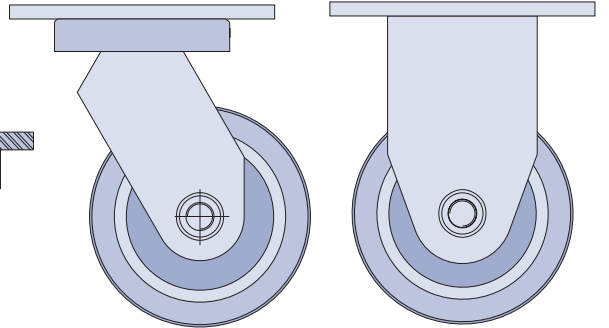
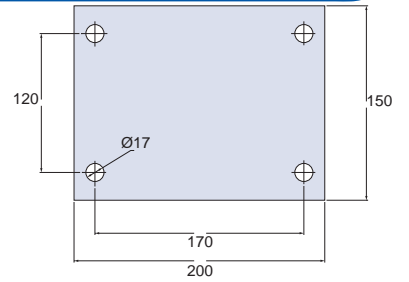
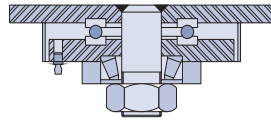

Wheels



Wheel Rotation Types



Accessories

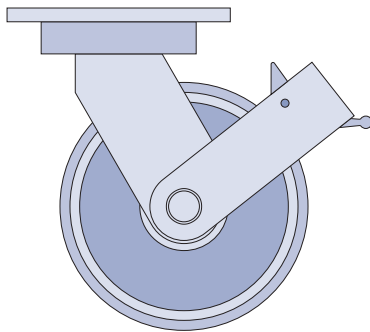

FP - Pedal brake

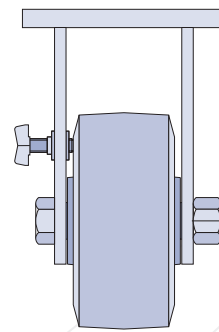

FL - Side brake

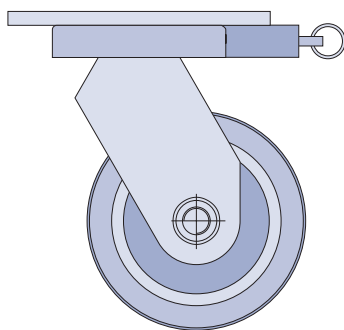



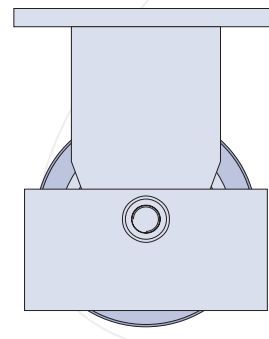



BG - Swivel direction lock





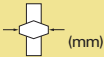
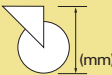
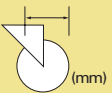





GC - Thread guard

MPX SERIES – Axial Medium Heavy Duty

SCHIOPPA

|  |  |  |  |  |  |  | Ref. Wheel | Ref. Caster with Top Plate | |
|---|---|---|---|---|---|---|------------|---|---|
| | | | | | | | |  |  |
| 6" | 70 | 1" | 78 | 218 | 132 | 300 | R 63 BR | GMPX 63 BR | FMPX 63 BR |
| | | | | | | 600 | R 63 PR | GMPX 63 PR | FMPX 63 PR |
| | | | | | | 600 | R 63 FR | GMPX 63 FR | FMPX 63 FR |
| | | | | | | 400 | R 63 CR | GMPX 63 CR | FMPX 63 CR |
| | | | | | | 500 | R 63 VR | GMPX 63 VR | FMPX 63 VR |
| 8" | 70 | 1" | 78 | 260 | 168 | 400 | R 83 BR | GMPX 83 BR | FMPX 83 BR |
| | | | | | | 800 | R 83 PR | GMPX 83 PR | FMPX 83 PR |
| | | | | | | 800 | R 83 FR | GMPX 83 FR | FMPX 83 FR |
| | | | | | | 550 | R 83 CR | GMPX 83 CR | FMPX 83 CR |
| | | | | | | 700 | R 83 VR | GMPX 83 VR | FMPX 83 VR |
| 10" | 70 | 1" | 78 | 320 | 200 | 500 | R 103 BR | GMPX 103 BR | FMPX 103 BR |
| | | | | | | 1000 | R 103 PR | GMPX 103 PR | FMPX 103 PR |
| | | | | | | 1000 | R 103 FR | GMPX 103 FR | FMPX 103 FR |
| | | | | | | 800 | R 103 CR | GMPX 103 CR | FMPX 103 CR |
| | | | | | | 900 | R 103 VR | GMPX 103 VR | FMPX 103 VR |
| 12" | 70 | 1" | 78 | 376 | 238 | 600 | R 123 BR | GMPX 123 BR | FMPX 123 BR |
| | | | | | | 1200 | R 123 PR | GMPX 123 PR | FMPX 123 PR |
| | | | | | | 1200 | R 123 FR | GMPX 123 FR | FMPX 123 FR |
| | | | | | | 900 | R 123 CR | GMPX 123 CR | FMPX 123 CR |
| | | | | | | 1000 | R 123 VR | GMPX 123 VR | FMPX 123 VR |

All dimensions in mm

|  |  |  |  (mm) |  (mm) |  (mm) |  | Ref. Wheel | Ref. Caster with Top Plate | |
|---|---|---|--|--|--|---|------------|---|---|
| | | | | | | | |  |  |
| 6" | 70 | 25 | 78 | 218 | 132 | 300 | R 63 BE | GMPX 63 BE | FMPX 63 BE |
| | | | | | | 600 | R 63 PE | GMPX 63 PE | FMPX 63 PE |
| | | | | | | 600 | R 63 FE | GMPX 63 FE | FMPX 63 FE |
| | | | | | | 400 | R 63 CE | GMPX 63 CE | FMPX 63 CE |
| | | | | | | 500 | R 63 VE | GMPX 63 VE | FMPX 63 VE |
| 8" | 70 | 25 | 78 | 260 | 168 | 400 | R 83 BE | GMPX 83 BE | FMPX 83 BE |
| | | | | | | 800 | R 83 PE | GMPX 83 PE | FMPX 83 PE |
| | | | | | | 800 | R 83 FE | GMPX 83 FE | FMPX 83 FE |
| | | | | | | 550 | R 83 CE | GMPX 83 CE | FMPX 83 CE |
| | | | | | | 700 | R 83 VE | GMPX 83 VE | FMPX 83 VE |
| 10" | 70 | 25 | 78 | 320 | 200 | 500 | R 103 BE | GMPX 103 BE | FMPX 103 BE |
| | | | | | | 1000 | R 103 PE | GMPX 103 PE | FMPX 103 PE |
| | | | | | | 1000 | R 103 FE | GMPX 103 FE | FMPX 103 FE |
| | | | | | | 800 | R 103 CE | GMPX 103 CE | FMPX 103 CE |
| | | | | | | 900 | R 103 VE | GMPX 103 VE | FMPX 103 VE |
| 12" | 70 | 25 | 78 | 376 | 238 | 600 | R 123 BE | GMPX 123 BE | FMPX 123 BE |
| | | | | | | 1200 | R 123 PE | GMPX 123 PE | FMPX 123 PE |
| | | | | | | 1200 | R 123 FE | GMPX 123 FE | FMPX 123 FE |
| | | | | | | 900 | R 123 CE | GMPX 123 CE | FMPX 123 CE |
| | | | | | | 1000 | R 123 VE | GMPX 123 VE | FMPX 123 VE |



All dimensions in mm