

PX SERIES – Axial Super Heavy Duty

SCHIOPPA

Load capacity up to 1200 kg.



Fastening Types

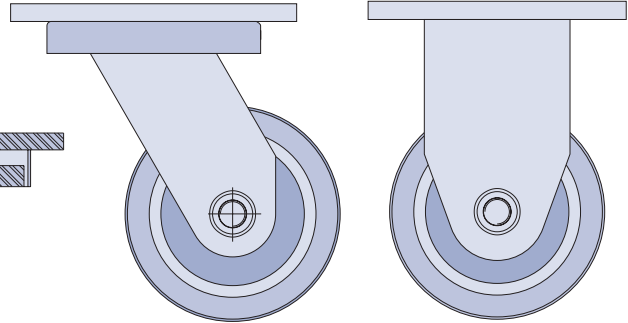
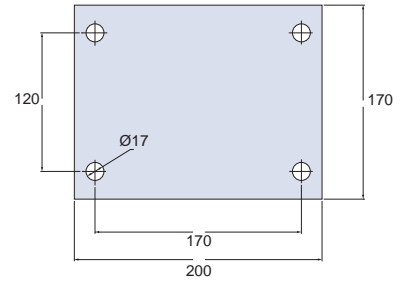
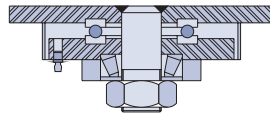

Wheels



Wheel Rotation Types



Accessories

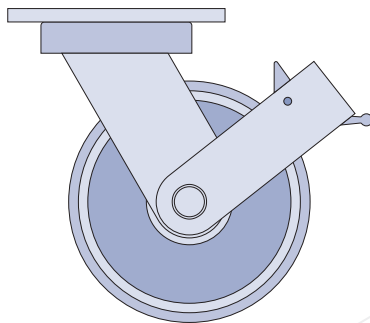

FP - Pedal brake

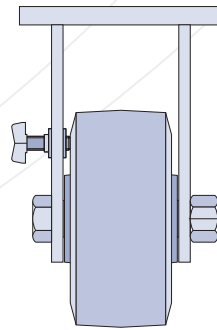

FL - Side brake

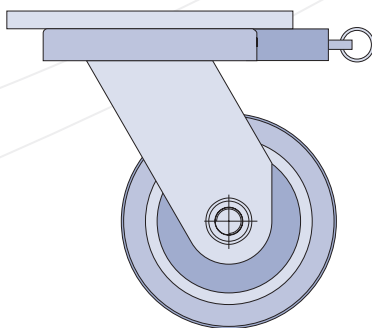



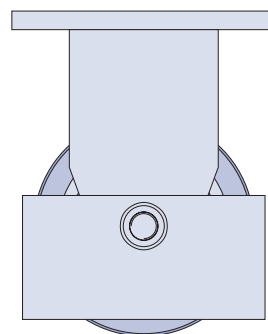





BG - Swivel direction lock

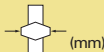

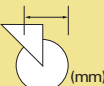
GC - Thread guard

All dimensions in mm









			 (mm)	 (mm)	 (mm)	 Kg	Ref. Wheel	Ref. Caster with Top Plate	
									
6"	70	1"	78	230	130	300	R 63 BR	GPX 63 BR	FPX 63 BR
						600	R 63 PR	GPX 63 PR	FPX 63 PR
						600	R 63 FR	GPX 63 FR	FPX 63 FR
						400	R 63 CR	GPX 63 CR	FPX 63 CR
						500	R 63 VR	GPX 63 VR	FPX 63 VR
8"	70	1"	78	275	168	400	R 83 BR	GPX 83 BR	FPX 83 BR
						800	R 83 PR	GPX 83 PR	FPX 83 PR
						800	R 83 FR	GPX 83 FR	FPX 83 FR
						550	R 83 CR	GPX 83 CR	FPX 83 CR
						700	R 83 VR	GPX 83 VR	FPX 83 VR
10"	70	1"	78	325	193	500	R 103 BR	GPX 103 BR	FPX 103 BR
						1000	R 103 PR	GPX 103 PR	FPX 103 PR
						1000	R 103 FR	GPX 103 FR	FPX 103 FR
						800	R 103 CR	GPX 103 CR	FPX 103 CR
						900	R 103 VR	GPX 103 VR	FPX 103 VR
12"	70	1"	78	370	228	600	R 123 BR	GPX 123 BR	FPX 123 BR
						1200	R 123 PR	GPX 123 PR	FPX 123 PR
						1200	R 123 FR	GPX 123 FR	FPX 123 FR
						900	R 123 CR	GPX 123 CR	FPX 123 CR
						1000	R 123 VR	GPX 123 VR	FPX 123 VR

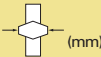

All dimensions in mm

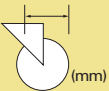
PX SERIES – Axial Super Heavy Duty

SCHIOPPA

							Ref. Wheel	Ref. Caster with Top Plate	
									
6"	70	25	78	230	130	300	R 63 BE	GPX 63 BE	FPX 63 BE
						600	R 63 PE	GPX 63 PE	FPX 63 PE
						600	R 63 FE	GPX 63 FE	FPX 63 FE
						400	R 63 CE	GPX 63 CE	FPX 63 CE
						500	R 63 VE	GPX 63 VE	FPX 63 VE
8"	70	25	78	275	168	400	R 83 BE	GPX 83 BE	FPX 83 BE
						800	R 83 PE	GPX 83 PE	FPX 83 PE
						800	R 83 FE	GPX 83 FE	FPX 83 FE
						550	R 83 CE	GPX 83 CE	FPX 83 CE
						700	R 83 VE	GPX 83 VE	FPX 83 VE
10"	70	25	78	325	193	500	R 103 BE	GPX 103 BE	FPX 103 BE
						1000	R 103 PE	GPX 103 PE	FPX 103 PE
						1000	R 103 FE	GPX 103 FE	FPX 103 FE
						800	R 103 CE	GPX 103 CE	FPX 103 CE
						900	R 103 VE	GPX 103 VE	FPX 103 VE
12"	70	25	78	370	228	600	R 123 BE	GPX 123 BE	FPX 123 BE
						1200	R 123 PE	GPX 123 PE	FPX 123 PE
						1200	R 123 FE	GPX 123 FE	FPX 123 FE
						900	R 123 CE	GPX 123 CE	FPX 123 CE
						1000	R 123 VE	GPX 123 VE	FPX 123 VE

All dimensions in mm