

Capacidade para até 80 Kg.

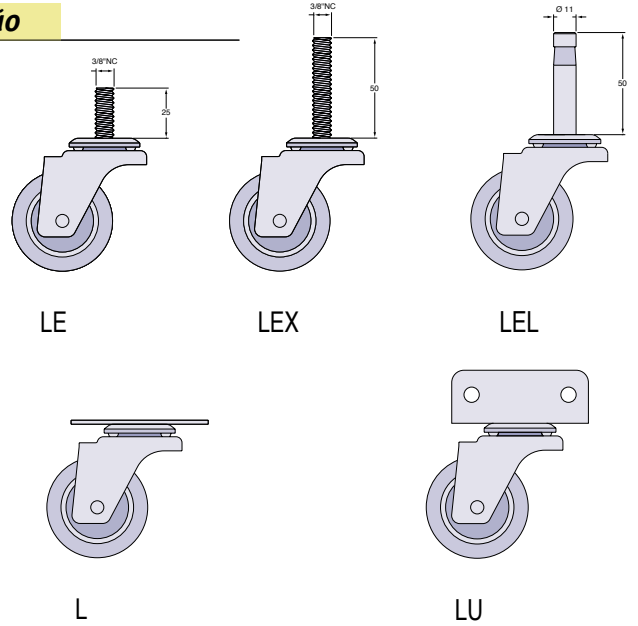

Tipos de Fixação



Rodas

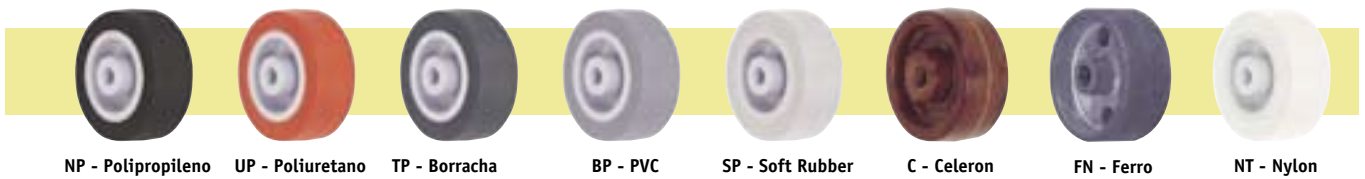



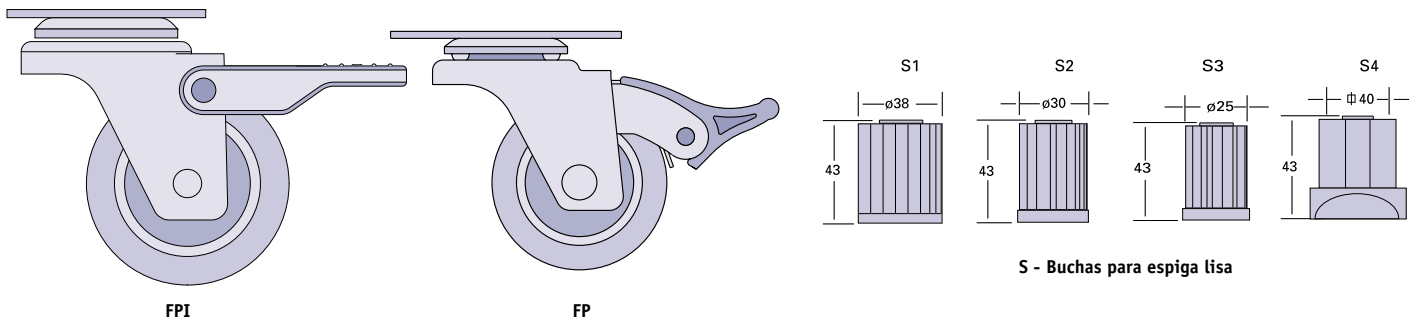



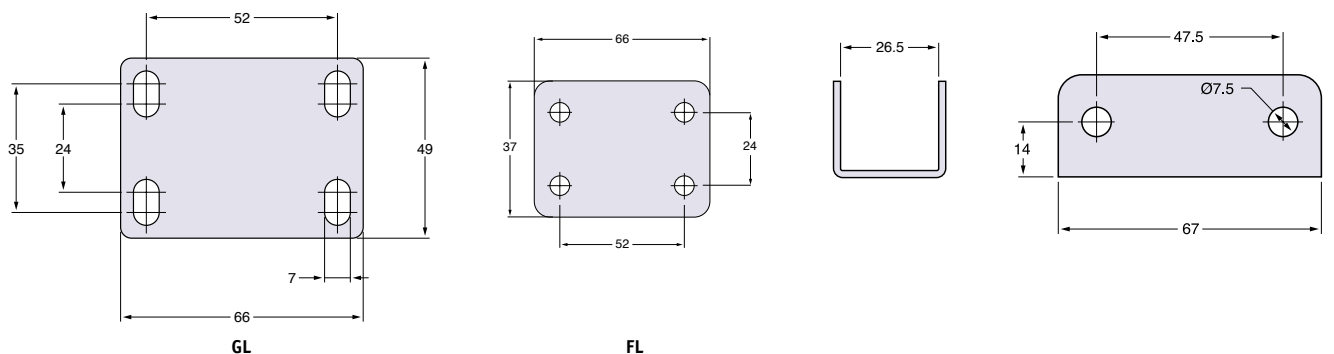

Acessórios

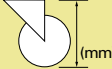

Fixação por Placa



			 (mm)	 (mm)	 (mm)		Ref. Roda	Ref. Rodízio com Placa	
									
1.5/8"	3/4"	1/4"	20	57	41	80	R 158 N	GL 158 N	FL 158 N
2"	3/4"	1/4"	25	67	45	30	R 210 BP	GL 210 BP	FL 210 BP
						45	R 210 NP	GL 210 NP	FL 210 NP
						40	R 210 TP	GL 210 TP	FL 210 TP
						45	R 210 UP	GL 210 UP	FL 210 UP
						30	R 210 SP	GL 210 SP	FL 210 SP
						80	R 210 NT	GL 210 NT	FL 210 NT
						80	R 210 C	GL 210 C	FL 210 C
						80	R 210 FN	GL 210 FN	FL 210 FN
3"	3/4"	1/4"	25	92	65	35	R 310 BP	GL 310 BP	FL 310 BP
						60	R 310 NP	GL 310 NP	FL 310 NP
						45	R 310 TP	GL 310 TP	FL 310 TP
						80	R 310 UP	GL 310 UP	FL 310 UP
						30	R 310 SP	GL 310 SP	FL 310 SP
						80	R 310 NT	GL 310 NT	FL 310 NT
4"	3/4"	1/4"	25	122	89	40	R 410 BP	GL 410 BP	FL 410 BP
						70	R 410 NP	GL 410 NP	FL 410 NP
						50	R 410 TP	GL 410 TP	FL 410 TP
						70	R 410 UP	GL 410 UP	FL 410 UP
						40	R 410 SP	GL 410 SP	FL 410 SP
						80	R 410 NT	GL 410 NT	FL 410 NT