







SUPERMERCADO

LESM - REFORÇADO

GARFO Fabricado em chapa estampada com espessura reforçada e cabeçote com dupla pista de esferas, acabamento zincado. Eixo da roda parafusado









Rodízio Giratório	Rodízio Giratório com Freio	Roda				Tipo de Rolamento			
Referência	Referência	Referência	(mm)	(mm)	(pol)		KG	(mm)	s/ freio (mm)
GLER 412 BPE	GLER 412 BPE G	R 412 BPE	100	32	5/16"	Rolamento de Esferas	100	126	80
GLER 512 BPE	GLER 512 BPE G	R 512 BPE	125				115	156	105

RODAS **BP - Composto Termoplástico com PVC. Dureza 80 Shore A. (-10°C a +50°C).** Produzidas em PVC, com calota anti-fios e rolamentos de esferas blindados, para aplicação em piso liso.







RTR - Poliuretano Termoplástico. Dureza: 60 Shore D. (-20°C a +70°C). Produzidas em poliuretano termoplástico, com calota anti-fios e rolamentos de esferas blindados, para aplicação em esteiras rolantes.

AU - Poliuretano Termoplástico. Dureza: 60 Shore D. (-20°C a +70°C). Produzidas com revestimento em poliuretano termoplástico, com calota anti-fios e rolamentos de esferas blindados, para aplicação em esteiras rolantes.



Giratório com Freio sem Sapata	Giratório com Freio com Sapata	Roda				Tipo de Rolamento			
Referência	Referência	Referência	(mm)	(mm)	(pol)		KG	(mm)	s/ freio (mm)
GLER 412 RTR	GLER 412 RTR C	R 412 RTR	100	32	5/16"	Rolamento de Esferas	100	126	80
GLER 512 RTR	GLER 512 RTR C	R 512 RTR	125					156	105



Giratório com Freio	Roda				Tipo de Rolamento			
Referência	Referência	(mm)	(mm)	(pol)		KG	(mm)	s/ freio (mm)
GLER 512 AU FF	R 512 AU	125	32	5/16"	Rolamento de Esferas	100	156	105

CONSULTE TABELA DE FREIOS AU

Tabela de Freios AU

MODELO	A	B	C	D	E
FREIO 414 AU - R	16	45,5	8,2	8	72,5
FREIO 414 AU - O	13	45,5	8,2	6	72,5
FREIO 414 AU - M	23,5	45,5	8,2	6	91,5
FREIO 414 AU - R	35	45,5	11,5	8	91,5
FREIO 414 AU - I	29	45,5	10	6	91,5
FREIO 512 AU - R	16	58	8,2	ℓ	85
FREIO 512 AU - O	13	58	8,2	ℓ	85
FREIO 512 AU - M	23,5	58	8,2	ℓ	104
FREIO 514 AU - R	29	58	11,5	ℓ	104
FREIO 514 AU - I	29	58	10	ℓ	104

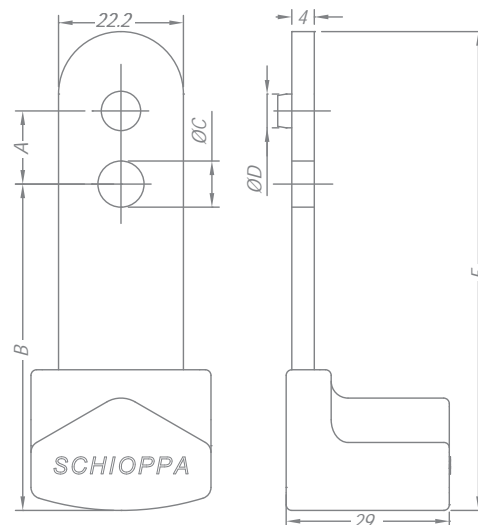

TIPOS DE GARFOS PARA CARRINHOS DE COMPRAS

Giratórios GLE E GLER

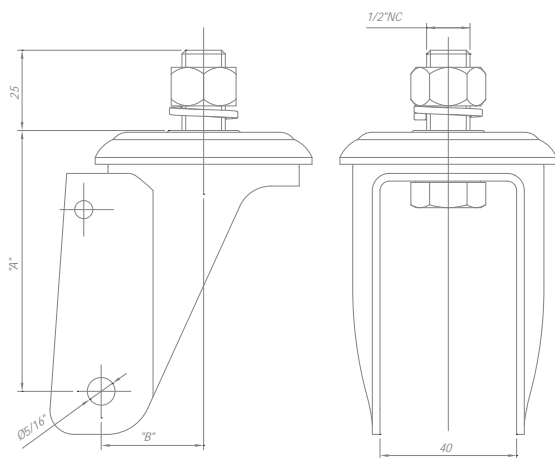

OBS: Os garfos são fornecidos sem acabamento superficial

PRODUTO	A	B
GARFO GGLE 412	76	30
GARFO GGLE 512	93,5	42,5

Fixos

GFLSM 412 FF

GFLSM 512

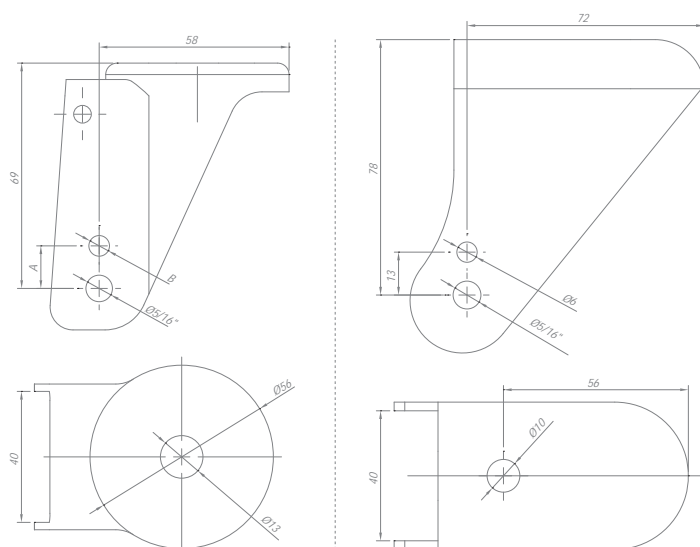

PRODUTO	A	B
GARFO GFLSM 412 FF FURO 1/2"	16	8
GARFO GFLSM 412 FF FURO 1/2"-0	13	6

Tipos de Roda



CÓDIGO	BPE	BPE ROUND	BPE-SM	BPEROUND-SM	TBE	TBE ROUND	TPE	TPE ROUND	UPE	UPE ROUND	AU	RTR			
(mm)	75	100	125	75	100	125	75	100	125	75	100	125			
(KG)	60	100	115	60	100	115	70	100	125	80	125	150			
MATERIAL	PVC			PVC - SM			BORRACHA TERMOPLÁSTICA			COMPOSTO TERMOPLÁSTICO			POLIURETANO		